

GXR Series

**Full Range  
Loudspeakers**

**GXR**

**o w n e r ' s**

**Manual**

**ATTACH YOUR RECEIPT  
HERE AND FILE FOR  
FUTURE REFERENCE  
X**

## GETTING STARTED

Please inspect each loudspeaker carefully. Notify your Polk Audio dealer if you notice any damage or missing items. Keep the carton and packing material. They will do the best job of protecting your speakers if they need to be transported. Check that you have the following parts:

- 2 Speakers
- 8 Mounting clips
- 2 Grilles (GXR4, GXR5, GXR6 & GXR69)
- 8 Screws
- 1 Mounting template (Separate Sheet)
- Online registration card
- Mail-in registration card

Installing car speakers is a serious project. If you have any doubts about your ability to execute any of the installation steps found in this manual, save yourself a lot of grief and contact a professional installer. Your Polk Audio dealer is a good place to find one. If you intend to do the installation yourself we assume you possess some skill in the proper use of hand and power tools. No matter how much installation experience you have, we recommend that you . . .

- Read this manual thoroughly before you begin
- Plan your installation carefully
- Allow enough time to complete the installation without rushing
- Take steps to protect your car and upholstery from unwanted scratches and punctures

## NECESSARY TOOLS

- Phillips head screwdriver
- Flat blade screwdriver or putty knife
- Door panel pry-tool (available at most auto parts supply stores)
- Electric drill
- 1/8" (3mm) Drill bit
- Tin snips (for removing flanges on GXR4 modes, for some import car applications, if necessary)
- Hole saw of appropriate diameter for the speaker size (for "new location" installation only)
- Permanent ink marker for marking the cutout (for "new location" installation only)
- Metal file
- Crimping tool
- Safety glasses
- Wire strippers and cutters

## INSTALLING GXR SERIES FULL RANGE LOUDSPEAKERS

### Installation in a factory location

1. Carefully remove the grille covering the factory speaker. In most cases it will be “press-fit” or screwed to mounting tabs molded into the surrounding area. If you experience any resistance, consult your dealer or your car’s owner’s manual to determine if there is any special way the manufacturer has secured the grille.
2. Remove all screws, mounting clips or lock washers holding the factory speaker in place and save them for reuse. Lift the speaker out of the hole a short distance.
3. Before unhooking the speaker wires, identify the positive speaker terminal (usually marked with a red dot or [+], or it is the terminal that is **larger or wider**) and identify the negative speaker terminal (usually marked [-], or having no marking, or whichever terminal is the smaller or narrower of the two). Mark the wire connected to the positive terminal for later identification. Use a permanent ink marker or piece of tape.
4. Disconnect the factory speaker. After disconnecting the factory speaker, connect the wires to your new Polk Audio speaker, hooking up the positive [+] wire to the **wider** of the two GXR terminals and the negative [-] to the narrower GXR terminal.
5. Mount your GXR Loudspeaker using the mounting hardware you saved from Step 2.
6. Remount the factory grille cover.
7. Repeat Steps 1-6 for the other speaker(s).

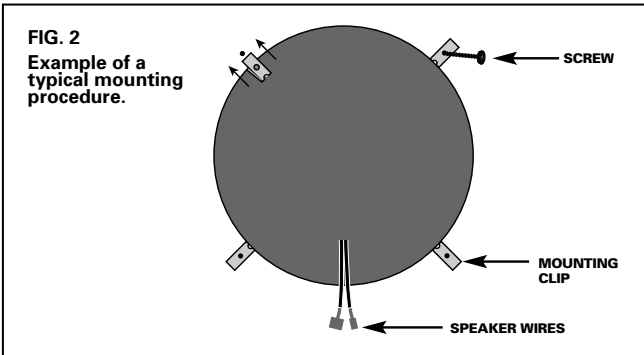
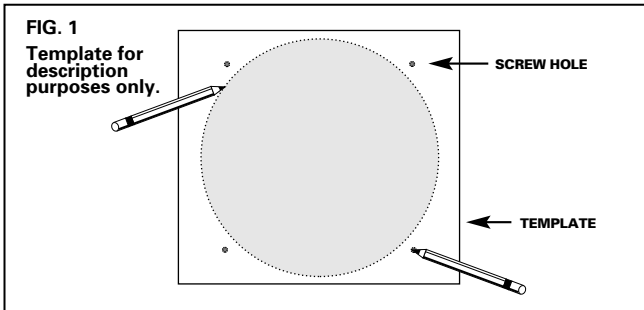

## Installing your speakers in a “New Location”

Factory locations uncool? Pick a new location. Be sure to take into account both your vehicle's design and your sonic goals. Door panels, kick panels or dashboards make the most sense for round or 4"x6" speakers. Before you begin, read all of these steps. If you have any doubts about your ability to execute any of these steps, save yourself a lot of grief and contact a professional installer. Your Polk Audio dealer is a good place to find one.

1. Using the door panel pry-tool, carefully remove any door panels, kick panels, molded parts or fabric coverings to expose the surface that will need to be cut to install the new speaker.
2. Check the dimensions around and behind the installation area for fit. This includes any moving parts behind the speaker (move the windows up and down) or the sides of the speaker (open and close doors).
3. Locate the template over the desired location. Draw the inside circle and mark at least two opposing screw locations. **(FIG. 1)**
4. Cut the circle with the appropriate tool. Drill pilot holes for the screw locations. File the edges of any bare metal surfaces until smooth, then coat with primer to prevent rust.
5. When primer is dry, slip mounting clips over the screw holes. **(FIG. 2)**
6. In the meantime, run wires from your amplifier or radio to the speaker locations. Use grommets when passing through doors.
7. Insert speaker into beauty ring.
8. Connect the wires to your new Polk Audio speakers. Hook the positive [+] wire to the **wider** of the two GXR terminals and the negative [-] to the narrower GXR terminal.
9. Carefully align the speaker and beauty ring holes over the new screw holes and mounting clips. Tighten the screws firmly to secure the speaker to the mounting surface.
10. Install mesh grille into beauty ring.
11. Repeat Steps 1-10 for the other speaker(s).

## **GXR4 SPECIAL INSTRUCTIONS FOR IMPORT APPLICATIONS (TOYOTA/MITSUBISHI)**

GXR4 models have flanges that can be removed to facilitate easy placement in tight spots, such as in some import vehicles (**FIG. 3**). Remove only the flange(s) that are necessary to make the speaker fit the chosen location. Secure the speaker with at least two opposing flanges. In some vehicles, you may have to bend or angle (but not break) one of the two flanges to get the proper fit when installing the speakers in your dashboard. To remove flanges, use tin snips. Do not use a sander or grinder, as that could cause fine metal shavings to fall into the voice coil and driver suspension units.

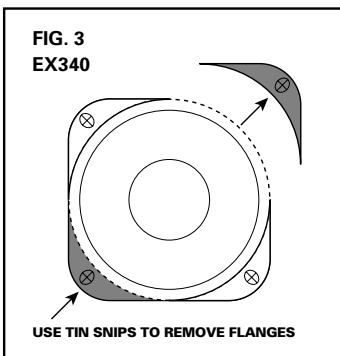

## LOW FREQUENCY CUT-OFF FOR SYSTEMS WITH SUBWOOFERS

If you have a subwoofer in your system, you may want to decrease the amount of bass frequencies going to your mid-range speakers (which is what your “full range” speakers would be if you had a subwoofer in your system). Doing this will result in better mid-range detail and increased power handling. There are two ways to roll off the bass before it gets to your mid-range speakers. One way is to use a “bass blocker,” a capacitor placed in series with the speaker input. Bass blockers are installed in series, one end connected with the positive lead from your amplifier and the other end connected to the positive lead of each of your speakers (**FIG. 4**). Bass blocker capacitors (200 microfarad @ 100volts, non-polarized) are available at most car stereo dealers, RadioShack and parts supply stores. The other route is to use an electronic crossover device that allows filtering below 100Hz or so. You can find these devices at your authorized Polk Audio dealer.

**FIG. 4**  
**Bass**  
**Blockers**

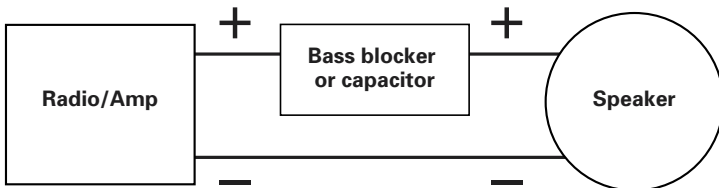

## **AMPLIFIER POWER REQUIREMENTS**

Your new GXR Loudspeaker will work well with a variety of electronic components. As little as 10 watts per channel will deliver adequate listening levels in most cars. If you have a noisy car or intend to play your system at loud listening levels, more power will be necessary to achieve the best performance. Consult your Polk Audio dealer for specific amplifier recommendations.

## **SAFE LIMITS OF OPERATION**

Your new GXR Loudspeakers are made with the highest quality materials for years of durable, trouble-free performance. However, damage can occur to loudspeakers when an amplifier, regardless of its wattage, is made to play at higher listening levels than its power can clearly produce. This is usually beyond the “1 to 2 o’clock” position on the volume control. This results in very high levels of audible distortion, originating in the amplifier, which add a harsh, gritty sound to your music. Contrary to popular belief, a speaker is more likely to be damaged by trying to get too much volume from a low-powered amp than from a high-powered one.

## **TECHNICAL ASSISTANCE OR SERVICE**

If, after following these hookup and installation directions, you experience difficulty, please double-check all wire connections.

Make certain your electronic equipment is operating correctly by hooking up another speaker to the speaker output. For example, if you are not getting sound from the left channel speaker, connect the right channel speaker to the left output. If you still get no sound from that side, the problem is in your amp or source electronics. Should you isolate the problem to the speaker, contact the authorized Polk Audio dealer where you bought your speakers. Authorized Polk Audio dealers are the best source for advice and assistance.

Polk Audio’s Customer Service Department is available from 9am–6pm, EST, Monday through Friday, at 800-377-7655, or via email [polkcs@polkaudio.com](mailto:polkcs@polkaudio.com). Please do not hesitate to contact us if you have questions about your speaker system.

**You will find additional information, informative articles, manual updates and cool stuff to buy that has “Polk Audio” all over it by visiting [www.polkaudio.com](http://www.polkaudio.com).**



## GXR SERIES FULL RANGE SPECIFICATIONS

	<b>GXR69</b>	<b>GXR6E</b>	<b>GXR6</b>	<b>GXR57</b>
Type	6" x 9" 3-way (152.4mm x 228.6mm)	6 1/2" euro coaxial (165.1mm)	6 1/2" coaxial (165.1mm)	5" X 7" coaxial (127mm x 177.8mm)
Driver Complement	6" x 9" (152.4mm x 228.6mm) woofer, 1 1/2" (38mm) PEI midrange, 1/2" (13mm) PEI tweeter	6 1/2" (165.1mm) mid/woofer, 1/2" (13mm) PEI tweeter	6 1/2" (165.1mm) mid/woofer, 1/2" (13mm) PEI tweeter	5" X 7" (127mm x 177.8mm) mid/woofer, 1/2" (13mm) PEI tweeter
Mounting Dimensions	5 7/8" x 8 9/16" (149.2mm x 218.2mm)	5 5/16" (134.9mm)	5" (127mm)	5" x 7 1/8" (127mm x 180.9mm)
Mounting Depth (top)	2 7/8" (73mm)	2 5/8" (66.7mm)	2 1/4" (57.2mm)	2 1/8" (54mm)
Mounting Depth (bottom)	3 3/8" (85.7mm)	2 3/4" (69.9mm)	2 1/2" (63.5mm)	2 1/2" (63.5mm)
Peak Power Handling	175w	125w	125w	125w
Continuous Power Handling	70w	50w	50w	50w
Nominal Impedance	4 ohms	4 ohms	4 ohms	4 ohms
Frequency Response	50-21kHz	60-21kHz	70-21kHz	57-21kHz
Grille Height	1 5/16" (33.5mm)	N/A	7/8" (22mm)	N/A
Grille Diameter	6 15/16" x 9 13/16" (175mm x 249mm)	N/A	6 3/4" (171.5mm)	N/A
Sensitivity	93dB	92dB	92dB	92dB

## GXR SERIES FULL RANGE SPECIFICATIONS

	<b>GXR5</b>	<b>GXR46</b>	<b>GXR4</b>
Type	5 1/4" coaxial (133.4mm)	4" X 6" coaxial (101.6mm x 152.4mm)	4" coaxial (101.6mm)
Driver Complement	5 1/4" (133.4mm) mid/woofer, 1/2" (13mm) PEI tweeter	4" X 6" (101.6mm x 152.4mm) mid/woofer, 1/2" (13mm) PEI tweeter	4" (101.6mm) mid/woofer, 1/2" (13mm) PEI tweeter
Mounting Dimensions	4 9/16" (15.9mm)	3 3/4" x 6" (95.3mm x 152.4mm)	3 3/4" (95.5mm)
Mounting Depth (top)	2" (50.8mm)	1 3/4" (44.5mm)	1 3/4" (44.5mm)
Mounting Depth (bottom)	2 1/4" (57.2mm)	2 1/16" (52.4mm)	1 7/8" (47.6mm)
Peak Power Handling	115w	88w	88w
Continuous Power Handling	45w	35w	35w
Nominal Impedance	4 ohms	4 ohms	4 ohms
Frequency Response	80-20kHz	95-21kHz	95-21kHz
Grille Height	3/4" (18.4mm)	N/A	7/8" (22mm)
Grille Diameter	6 1/4" (158mm)	N/A	5 7/16" (138mm)
Sensitivity	91dB	91dB	91dB

## **GXR SERIES 1 YEAR WARRANTY**

Polk Audio, Inc. warrants the original purchaser only that this Polk Audio GXR Series Product (the Product) will be free from defects in materials and workmanship for a period of (1) one year from the date of original retail purchase from a Polk Audio Authorized Dealer. However, this warranty will automatically terminate prior to the expiration of the (1) one year period if the original retail purchaser sells or otherwise transfers the Product to any other party. The original retail purchaser shall herein after be referred to as “you.” To allow Polk Audio to offer the best possible warranty service, please fill out the Product Registration Card(s) and send them to the Factory at the address provided in the Registration Card within (10) ten days of the date of purchase.

Defective Products must be shipped, together with a proof of purchase, prepaid insured to the Authorized Polk Audio Dealer from whom you purchased the Product, or to Polk Audio, 2550 Britannia Blvd., Suite D, San Diego, CA 92154. Products must be shipped in the original shipping container or its equivalent; in any case the risk of loss or damage in transit is to be borne by you. If, upon examination at the Factory or Polk Audio Authorized Dealer it is determined that the unit was defective in materials or workmanship at any time during the Warranty period, Polk Audio or the Polk Audio Dealer will, at its option, repair or replace this Product at no additional charge, except as set forth below. All replaced parts and Products become property of Polk Audio. Products replaced or repaired under this Warranty will be returned to you, within a reasonable time, freight prepaid.

This Warranty does not include service or parts to repair damage caused by accident, disaster, misuse, abuse, negligence, inadequate packing or shipping procedures, commercial use, voltage inputs in excess of the rated maximum of the unit, cosmetic appearance of the cabinetry not directly attributable to defects in materials or workmanship, or service, repair, or modifications of the Product which has not been authorized or approved by Polk Audio.

This Warranty is in lieu of all other expressed Warranties. If this Product is defective in materials and workmanship as warranted above, your sole remedy shall be repair or replacement as provided above. In no event will Polk Audio, Inc. be liable to you for any incidental or consequential damages arising out of the use or inability to use the Product, even if Polk Audio, Inc. or a Polk Audio Dealer has been advised of the possibility of such damages, or any other claim by any other party. Some states do not allow the exclusion or limitation of consequential damages, so the above limitation and exclusion may not apply to you. This Warranty gives you specific legal rights which may vary from state to state.

This warranty applies only to Products purchased in the United States of America, its possessions, and U.S. and NATO armed forces exchanges and audio clubs. The Warranty terms and conditions applicable to Products purchased in other countries are available from the Polk Audio Authorized Distributors in such countries.

# GXR

**polkaudio**  
the speaker specialists®

**POLK AUDIO  
5601 METRO DRIVE  
BALTIMORE, MARYLAND 21215  
(800)377-7655**



<http://www.polkaudio.com>

R E G I S T E R

**Online**

---

It's faster...easier...and you get **COOL** stuff!

**Register on-line to get:**

- An entry into a monthly drawing for a free Polk subwoofer (home or car, your choice)
- The peace of mind that we have a record of your purchase to verify purchase date and warranty status.
- **Privacy.** The data we gather on our on-line registration is never sold or otherwise shared with anyone.
- **Free membership in Club Polk.** Club Polk members enjoy valuable services and benefits not available to the general public.
- A **free subscription** to Polk's newspaper *The Speaker Specialist*, to help you get better performance and more enjoyment from your audio system.



[www.polkaudio.com/car/registration](http://www.polkaudio.com/car/registration)

**1** First Name: \_\_\_\_\_ Initial: \_\_\_\_\_ Last Name: \_\_\_\_\_  
 Address: (Number and Street) \_\_\_\_\_ Apt #: \_\_\_\_\_  
 City: \_\_\_\_\_ State: \_\_\_\_\_ Zip Code: \_\_\_\_\_

**2** Phone #: \_\_\_\_\_

**3** E-mail Address: \_\_\_\_\_  
 If you voluntarily provide us with your email address, you give us permission to share and use your email address to send you email offers that may interest you.  
 (EXAMPLE: yourname@yourhost.com)

**4** Date of Purchase: \_\_\_\_\_  
 Month Day Year

**6** Store Name: \_\_\_\_\_

**7** Who installed this product?  
 1.  Self 2.  Professional 3.  Friend / Relative

**8** Did the following reasons influence your purchase of this Polk Audio product?

	Yes	No
1. Polk Audio Reputation	<input type="checkbox"/>	<input type="checkbox"/>
2. Ease of Use	<input type="checkbox"/>	<input type="checkbox"/>
3. Appearance	<input type="checkbox"/>	<input type="checkbox"/>
4. Recommendation of Dealer	<input type="checkbox"/>	<input type="checkbox"/>
5. Recommendation of Family/Friend	<input type="checkbox"/>	<input type="checkbox"/>
6. Magazine Review	<input type="checkbox"/>	<input type="checkbox"/>
7. Quality of Sound	<input type="checkbox"/>	<input type="checkbox"/>
8. Technical Specifications	<input type="checkbox"/>	<input type="checkbox"/>
9. Value for Price	<input type="checkbox"/>	<input type="checkbox"/>
10. Prior Experience with Polk Audio	<input type="checkbox"/>	<input type="checkbox"/>

**9** Where have you seen Polk products featured? (Check all that apply)  
 1.  Magazine advertisement 4.  In-store advertising  
 2.  Polk literature 5.  Someone else's home or car  
 3.  Magazing review 6.  On-line computer bulletins

**10** What other brands did you consider? (Check all that apply)  
 1.  No other brands 12.  KEF  
 2.  Advent 13.  Kenwood  
 3.  Alpine 14.  Kicker  
 4.  Atec 15.  MB Quart  
 5.  Boston Acoustics 16.  MTX  
 6.  Canton 17.  Pioneer  
 7.  Cerwin-Vega 18.  Rockford Fosgate  
 8.  Clarion 19.  Sony  
 9.  Infinity 20.  Soundstream  
 10.  JBL 21.  Other \_\_\_\_\_  
 11.  Jensen

**11** In what automobile will this Polk Audio product be installed?

Make: \_\_\_\_\_  
 EXAMPLE: FORD

Model: \_\_\_\_\_  
 EXAMPLE: MUSTANG

Year: \_\_\_\_\_  
 EXAMPLE: 1965

**12** Your gender: 1.  Male 2.  Female

**13** Your marital status: 1.  Married 2.  Single

**14** Date of your birth: \_\_\_\_\_  
 Month Day Year

**15** Date of birth (month/year) of the other adults and children in your household:

Male	Female	Male	Female
1. <input type="checkbox"/> 2. <input type="checkbox"/>	1. <input type="checkbox"/> 2. <input type="checkbox"/>	1. <input type="checkbox"/> 2. <input type="checkbox"/>	1. <input type="checkbox"/> 2. <input type="checkbox"/>
Month Year	Month Year	Month Year	Month Year
1. <input type="checkbox"/> 2. <input type="checkbox"/>	1. <input type="checkbox"/> 2. <input type="checkbox"/>	1. <input type="checkbox"/> 2. <input type="checkbox"/>	1. <input type="checkbox"/> 2. <input type="checkbox"/>
Month Year	Month Year	Month Year	Month Year

**5** Serial Number: \_\_\_\_\_



**16** Including yourself, what is the total number of people living in your household?  
 (Examples: 01, 02, 03, 04...) \_\_\_\_\_

**17** For your primary residence, do you:  
 1.  Own 2.  Rent

**18** Which best describes your family income?  
 1.  Under \$15,000 7.  \$100,000-\$124,999  
 2.  \$15,000-\$24,999 8.  \$125,000-\$149,999  
 3.  \$25,000-\$34,999 9.  \$150,000-\$174,999  
 4.  \$35,000-\$49,999 10.  \$175,000-\$199,999  
 5.  \$50,000-\$74,999 11.  \$200,000-\$249,999  
 6.  \$75,000-\$99,999 12.  \$250,000 or over

**19** Education:  
 (Please check which category applies to you):  
 1.  Some high school 3.  College degree  
 2.  Completed high school 4.  Graduate degree

**20** In the last six (6) months has anyone in your household purchased any of the following items through the mail and/or over the internet?

	A. Mail	B. Internet
1. Books/magazines	<input type="checkbox"/>	<input type="checkbox"/>
2. Children's products	<input type="checkbox"/>	<input type="checkbox"/>
3. Clothes	<input type="checkbox"/>	<input type="checkbox"/>
4. Insurance/financial products	<input type="checkbox"/>	<input type="checkbox"/>
5. Music/video/DVD	<input type="checkbox"/>	<input type="checkbox"/>
6. Travel	<input type="checkbox"/>	<input type="checkbox"/>
7. Other	<input type="checkbox"/>	<input type="checkbox"/>

**21** I use these credit cards:  
 1.  American Express 4.  Visa  
 2.  Gas/Retail 5.  Other \_\_\_\_\_  
 3.  Master Card 6.  Do not have credit cards

**22** Someone in my home participates in the following activities:  
 (Check all that apply)

1. <input type="checkbox"/> Automotive work	19. <input type="checkbox"/> Hunting/Shooting
2. <input type="checkbox"/> Bible/devotional	20. <input type="checkbox"/> Investments (mutual funds, IRAs)
3. <input type="checkbox"/> Boating/sailing	21. <input type="checkbox"/> Investments (stocks & bonds)
4. <input type="checkbox"/> Camping/hiking	22. <input type="checkbox"/> Movie watching
5. <input type="checkbox"/> Casino gambling	23. <input type="checkbox"/> Own a cat
6. <input type="checkbox"/> Contribute to charitable causes	24. <input type="checkbox"/> Own a dog
7. <input type="checkbox"/> Crafts	25. <input type="checkbox"/> Personal computing / internet
8. <input type="checkbox"/> Cultural art/events	26. <input type="checkbox"/> Photography
9. <input type="checkbox"/> Cycling	27. <input type="checkbox"/> Read books
10. <input type="checkbox"/> Do-it-yourself	28. <input type="checkbox"/> Snow skiing
11. <input type="checkbox"/> Enter sweepstakes/contests	29. <input type="checkbox"/> Self improvement
12. <input type="checkbox"/> Fishing	30. <input type="checkbox"/> Soccer
13. <input type="checkbox"/> Fitness/exercise/jogging	31. <input type="checkbox"/> Tennis
14. <input type="checkbox"/> Gardening	32. <input type="checkbox"/> Travel-Foreign
15. <input type="checkbox"/> Golf	33. <input type="checkbox"/> Travel-U.S
16. <input type="checkbox"/> Gourmet cooking/food/wines	34. <input type="checkbox"/> TV shopping
17. <input type="checkbox"/> Grandchildren	35. <input type="checkbox"/> Vitamins/natural foods
18. <input type="checkbox"/> Home decorating	36. <input type="checkbox"/> Watch sports on TV

**COMMENTS:** \_\_\_\_\_

Thank you for purchasing

# polkaudio

the speaker specialists®

Please send other correspondence to:

Polk Audio, Inc.  
5601 Metro Drive  
Baltimore, MD 21215

129 F

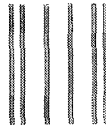

NO POSTAGE  
NECESSARY  
IF MAILED  
IN THE  
UNITED STATES

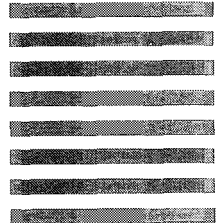

**BUSINESS REPLY MAIL**  
FIRST-CLASS MAIL PERMIT NO. 18230 BALTIMORE, MD

POSTAGE WILL BE PAID BY ADDRESSEE

**polkaudio**  
the speaker specialists®

**PRODUCT REGISTRATION DEPARTMENT  
5601 METRO DRIVE  
BALTIMORE MD 21215-9956**

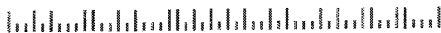

## RETURN THIS CARD TODAY AND RECEIVE THESE 3 IMPORTANT BENEFITS:



### WARRANTY CONFIRMATION:

Your prompt product registration confirms your right to the protection available under the terms and conditions of your Polk Audio warranty.



### PRODUCT PROTECTION:

We will keep the model number and date of purchase of your speakers on file in the event of an insurance claim such as theft or loss.



### PRODUCT REGISTRATION:

Returning this card is your only way to guarantee that you will be notified by Polk Audio of any issues that arise concerning this product.



Please send other correspondence to:

Polk Audio, Inc.  
5601 Metro Drive  
Baltimore, MD 21215

129 F

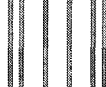

NO POSTAGE  
NECESSARY  
IF MAILED  
IN THE  
UNITED STATES

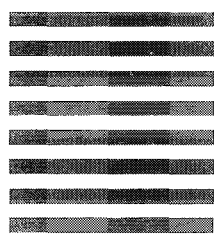

**BUSINESS REPLY MAIL**

FIRST-CLASS MAIL PERMIT NO. 18230 BALTIMORE, MD

POSTAGE WILL BE PAID BY ADDRESSEE



**PRODUCT REGISTRATION DEPARTMENT**  
**5601 METRO DRIVE**  
**BALTIMORE MD 21215-9956**



RM 0268-2

**PRODUCT REGISTRATION CARD**



By completing and returning the attached  
Product Registration Card you will:

- CONFIRM YOUR WARRANTY
- REGISTER YOUR PRODUCT
- PROTECT YOUR NEW PRODUCT